

MONOTRAC POWER RTS 230 V INSTALLATION

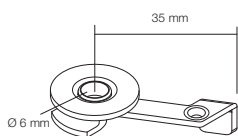

Tension jack Galvanised metal for ceiling fixation

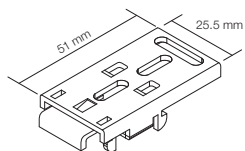

Clip White metal for ceiling fixation

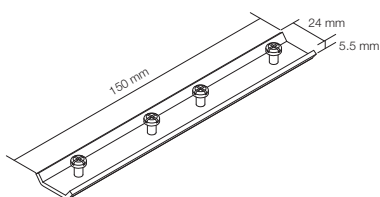

Rail joint Metallic plate, zinc plated with fixing screws

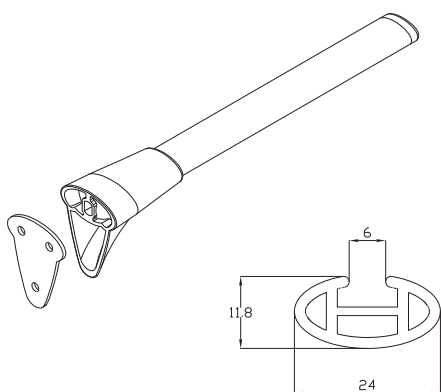

Universal bracket Wall fixation with aluminium brackets, cutting to size on-site possible

Colours Standard anodized aluminium
Standard white RAL 9016
Other colours upon inquiry

Measures	Length	Height
	approx. 130-150 mm	approx. 55 mm
	approx. 180-200 mm	approx. 55 mm
	approx. 230-250 mm	approx. 55 mm

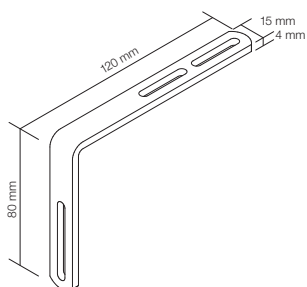

Wall support Fixing to wall with galvanized metal support

Colours Standard galvanized grey
Standard white RAL 9016
Other colours upon inquiry

Measures	Length	Height
	approx. 50 mm	approx. 60 mm
	approx. 80 mm	approx. 80 mm
	approx. 100 mm	approx. 80 mm
	approx. 120 mm	approx. 80 mm
	approx. 150 mm	approx. 80 mm
	approx. 180 mm	approx. 100 mm

MONOTRAC POWER RTS 230 V INSTALLATION

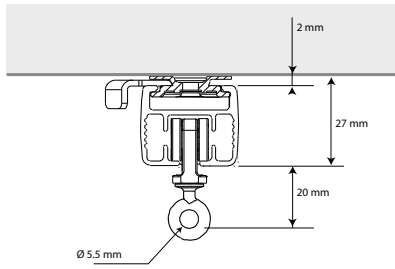

Ceiling fixation with tension jack

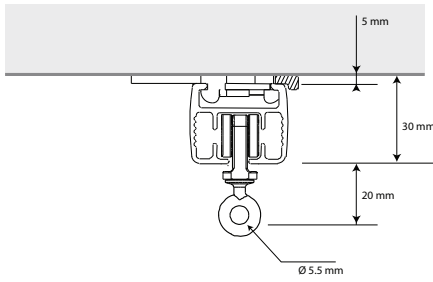

Ceiling fixation with clip

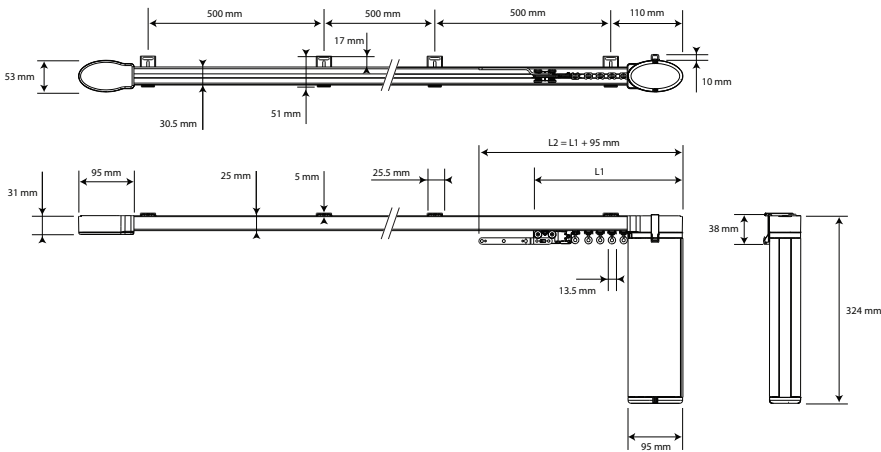

Lateral opening (one way)

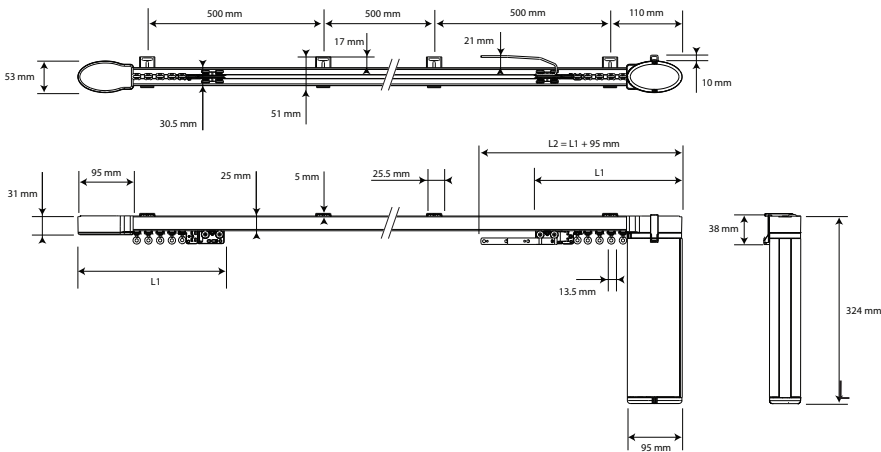

Central opening (two way)

Stack size:
 $L1 = 175 \text{ mm} + \text{number of runners}$
 (13,5 mm per runner)
 $L2 = L1 + 95 \text{ mm}$